

**UVS - UTILITY VENT SET FAN  
 ACCESS DOOR ACCESSORY**

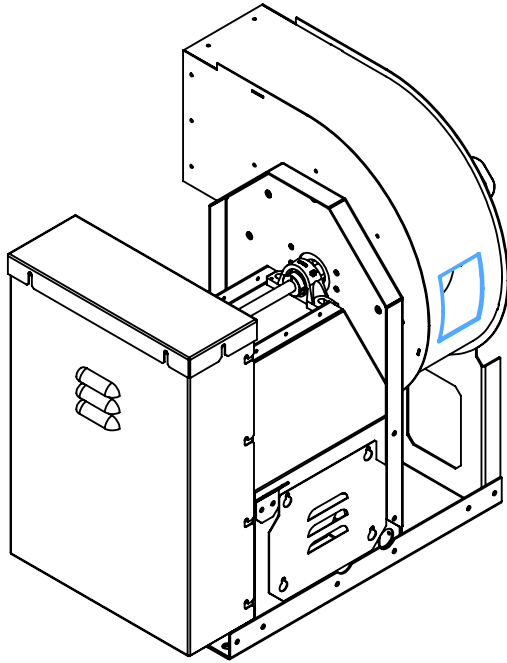
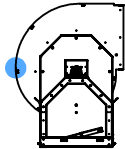
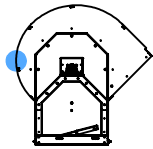
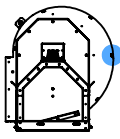
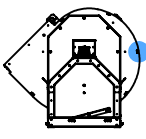
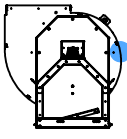
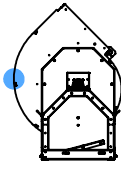
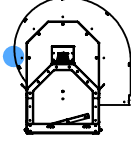
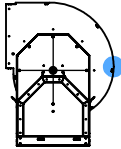
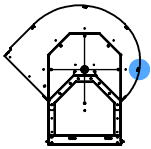
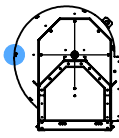
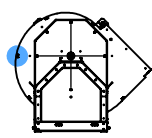
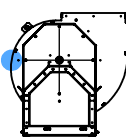
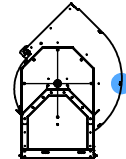
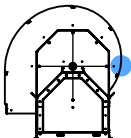

- Provides easy inspection or cleaning of the fan interior and wheel
- Options for Bolted or Hinged type
- Gasketed to minimize leakage
- Door material is same as housing
- Required when piezo ring or UL762 is selected
- Door location varies based on rotation and discharge

ACCESS DOOR LOCATION IS DEPENDENT ON ROTATION AND DISCHARGE

 CW-TH	 CW-TAD	 CW-BH	 CW-BAU	 CW-UB	 CW-TAU	 CW-DB
 CCW-TH	 CCW-TAD	 CCW-BH	 CCW-BAU	 CCW-UB	 CCW-TAU	 CCW-DB

**DISCHARGE POSITIONS**

● INDICATES STANDARD DOOR LOCATION